

---

# Product Specification

08/2019

---

**Product** TFT LCD Display

**Mode**

**Abbreviation** 860C-八方 CAN 新欧标

---

**Client**

**Customer**

**audit**

---

**Supplier** APT (Tianjin) Develop Co., Ltd.

1001, Building 5 HuaDing, No.1 HuaKe 3  
Road, Binhai hi-tech Industrial Development  
Zone, Tianjin, China

**Tel** TEL:+86 22 83715556  
FAX:+86 22 83719955

**Email** [yzhao@aptdevelop.com](mailto:yzhao@aptdevelop.com)

---

---

## 1. Product Name

- ✧ TFT LCD display
- ✧ Model : 860C

## 2. Suppliers

- ✧ APT (Tianjin) Develop Co., Ltd.

## 3. Electrical Parameters

- ✧ 3.5inch IPS screen
- ✧ 24V/36V/48V/52V battery supply
- ✧ Rated operating current : 40mA
- ✧ Max operating current : 100mA (36V battery, with USB equipment changed)
- ✧ USB changing port : 5V 500mA
- ✧ Off leakage current < 1uA
- ✧ Operating temperature : -20~70°C, Storage temperature : -30~80°C

## 4. Dimensions & Material

- ✧ Product shell is ABS+PC, LCD transparent window is imported super tempered glass, full bonding process.
- ✧ Dimensions : host/L96.6mm\*W71.6mm\*H6.1mm



## 5. Features

- ✧ Suitable for low temperature, Max -20°C.
-

- ✧ High-contrast 3.5inch IPS colorful matrix screen.
- ✧ Ergonomic external button design, easy to operate.
- ✧ **Speed display:** AVG SPEED, MAX SPEED, SPEED(Real-time).
- ✧ **Kilometer / Mile:** Can be set according to customers' habits.
- ✧ **Smart battery indicator:** Provide a reliable battery indicator.
- ✧ **Maintain reminded:** Maintenance icon to be determined.
- ✧ **9-level Assist :** 3-level/5-level/9-level optional.
- ✧ **Mileage indicator:** Odometer/Trip distance/ Clock/ Riding time/Range.
- ✧ **Power/Current indicator:** real time power indicator or Current.
- ✧ **Error code indicator.**
- ✧ **Light sensor (Optional )**
- ✧ **Software upgraded:** Software can be upgraded through UART.
- ✧ **USB charging port :** 5V/500mA

## 6. TFT screen instructions



## 7. Functional Description



### 7.1 Power On/Off

Press and hold **Power** button for 1 second, the controller can turn on/off display. The controller can automatically shut down the display when there is no operate & ride for X minutes (X could be 0~9) .

### 7.2 Assist level operating

Short press **UP/DOWN** button can change the assist level. Top assist level is 9, 0 for neutral. Level quantities can be adjusted according to the customer requirements.



### 7.3 Speed & Mileage mode switch

Short press **MENU** button can change the speed and mileage mode, TRIP→ODO→RANGE→TRIP→TIME→MAX SPEED→AVG SPEED

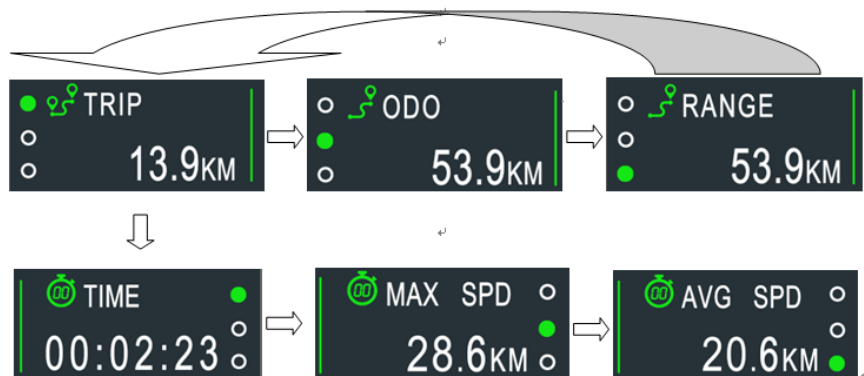

\*Range need smart BMS support.

\*\*If there is no operation for 5 seconds, display will return Speed (Real-Time) display automatically.

---

## 7.4 Headlight/backlight On/Off

Press and hold **UP** button for 1 second can turn on/off the headlight, and the screen will switch to the corresponding mode.



\*The motor does not work when the battery voltage is low, Display still can keep the headlight on for a while when E-bike is in riding.



Daytime mode

night mode

## 7.5 Walking mode (6km)

Press **DOWN** button → 0-level →  walk-level → press and hold **DOWN** button →  flash, the bike get into walking mode, out of the mode when release the button.



\* This feature needs to be supported by controller.

## 7.6 Data cleanup

Press and hold **UP** & **DOWN** buttons together for 1 second can reset several temporary data, temporary data include **AVG Speed / MAX Speed / Trip / Time**.

\* These temporary data can't be erased by power off.

## 8. Parameter setting

---

Double press **MENU** button (press interval less than 0.3 second) can get into setting menus, press **UP/DOWN** buttons to change the parameter setting, and press **MENU** button can switch to next item. Double press **MENU** button will exit from menu.

\* Display will automatically quit menu when there is no operation for 30 seconds.

\* For safety reasons, display can't get into MENU when riding.

\* Display will quit MENU when start riding.

The order of parameters is as follow.

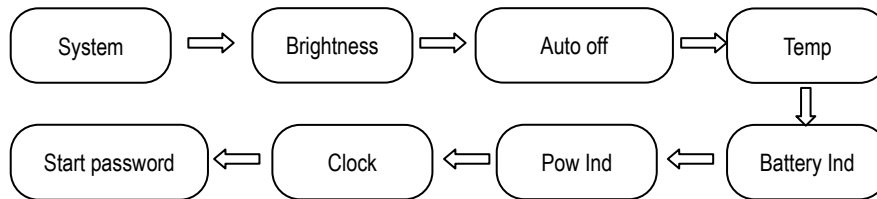

### 8.1 Language: Default EN , Un adjustable

MENU	
<b>Display Setting</b>	
→ Language	EN
System	Metric
Brightness	
Auto off	8 min
Temp	hide
Battery Ind	Percent
Pow Ind	Current
Clock	>
Start Password	>
<b>Basic Setting</b>	
...	
EXIT	

### 8.2 System: Press Up / Down button to switch between Metric / Imperial.

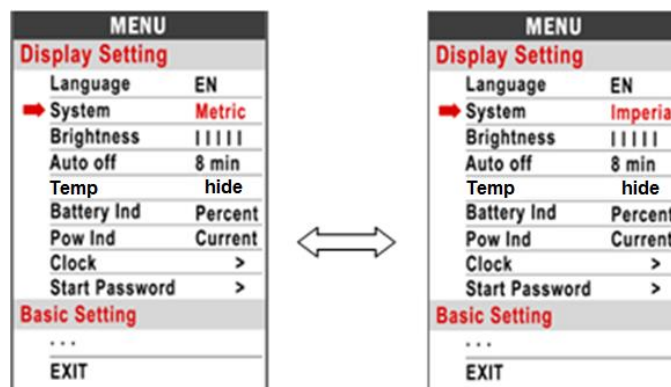

### 8.3 Brightness : Press Up / Down button to change the brightness of the backlight, | is darkness, ||||| is brightness, default value is |||||.

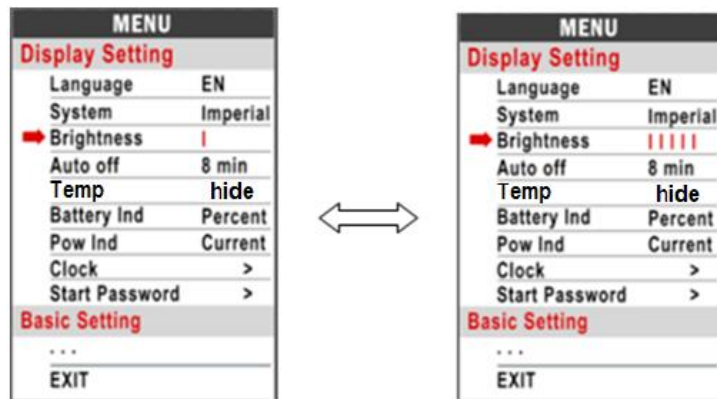

Note: You can set brightness independently between Daytime mode and Night mode.

**8.4 Auto off :** Press UP/DOWN button to change the auto power off time, from 1 to 9/OFF, the number represent minutes to shutdown, OFF means disable auto off function, default value is 5 minutes.

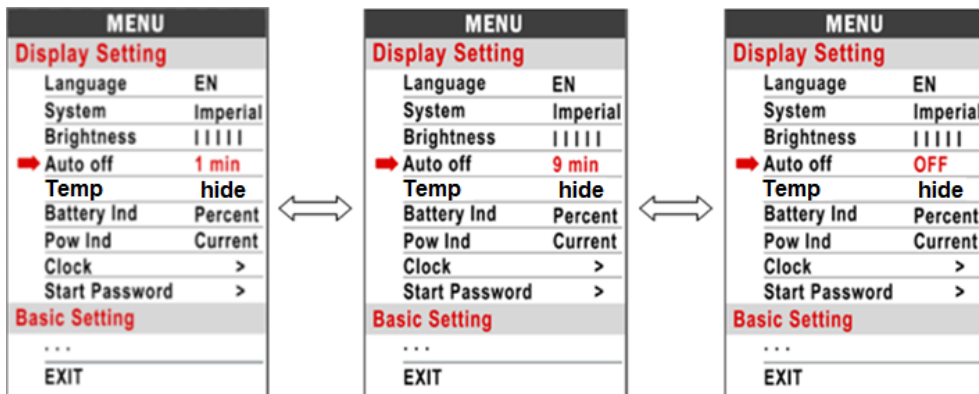

**8.5 Temp:** hide only.

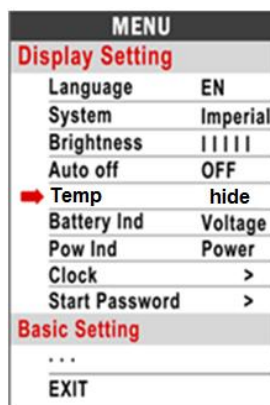

**8.6 Battery Ind:** Press UP/DOWN button to change the battery indicator, Voltage / Percentage / OFF.



Voltage

Percentage

OFF

**8.7 Pow Ind:** Press UP/DOWN button to change the Power indicator, Power / Current.

\* This data represent power output of the battery (not motor).

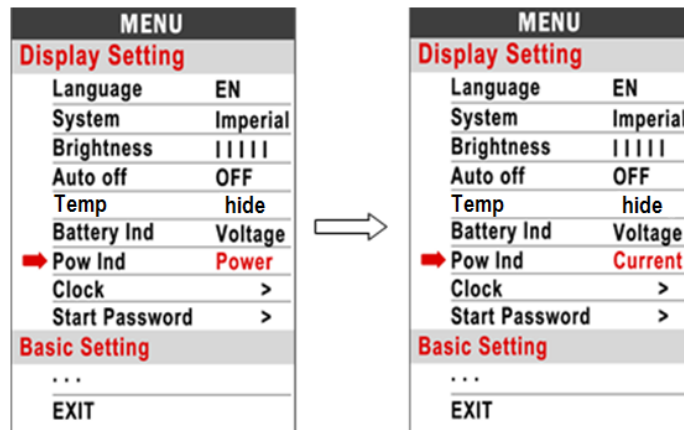





**8.8 Clock:** Clock setting, press MENU button get into the clock setting menu, press UP/DOWN button to set Year/Month/Day/Hour/Min/Sec/Clock(show or hide).

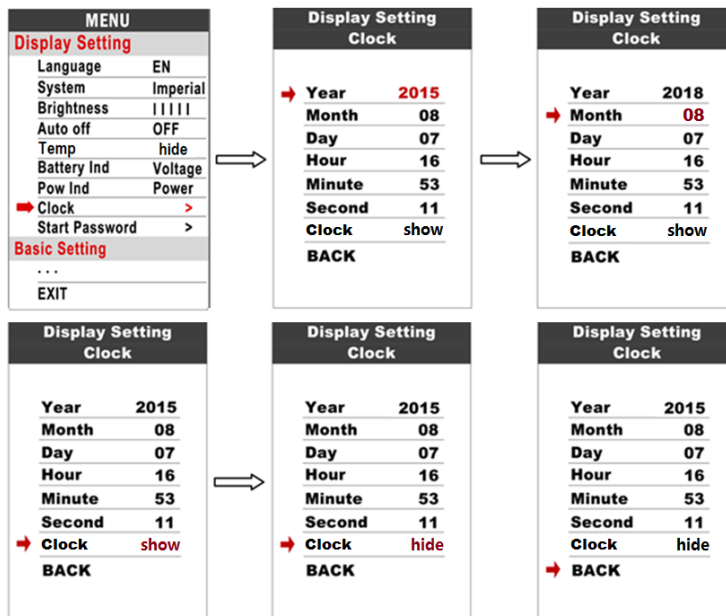

Note: There is a rechargeable battery inside display, it keeps the clock running when display is powered off. The battery can be charged by the external power when display is power on. This battery can maintain clock running for 100-120 days while it has not been charged. Battery may be exhausted after long time unused (after winter or transportation), you need to recharge the battery as below.

Set Menu: Auto off -> OFF (make display can't power off automatically)

Keep the display power on for 72 hours, it can charge the battery.

**8.9 Start password:** Currently the controller does not support and cannot be set.

MENU	
<b>Display Setting</b>	
Language	EN
System	Imperial
Brightness	
Auto off	OFF
Temp	hide
Battery Ind	Voltage
Pow Ind	Power
Clock	>
Start Password	>
<b>Basic Setting</b>	
...	
EXIT	

## Basic Setting

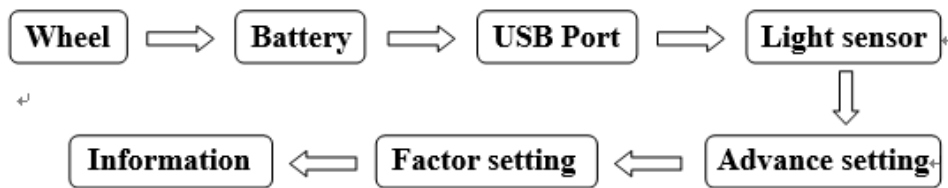

\*Press DOWN button to move the red arrow to **Basic Setting**, press **MENU** button can show all items of the Basic Setting.

- 8.10 Wheel:** Displays the wheel diameter value transmitted by the controller (this needs controller support).

MENU	
<b>Display Setting</b>	
Language	EN
System	Imperial
...	
<b>Basic Setting</b>	
Wheel	27.5 inch
Battery	36 V
USB Port	ON
Light sensor	>
Advance setting	>
Factory setting	>
Informations	>
EXIT	

- 8.11 Battery:** Displays the battery voltage value transmitted by the controller (this needs controller support).

MENU	
<b>Display Setting</b>	
Language	EN
System	Imperial
...	
<b>Basic Setting</b>	
Wheel	27.5 inch
➔ Battery	36 V
USB Port	ON
Light sensor	>
Advance setting	>
Factory setting	>
Informations	>
EXIT	

8.12 USB Port: press **UP/DOWN** button, select press **OFF/ON**, Will be no Voltage/Current output after switching off.

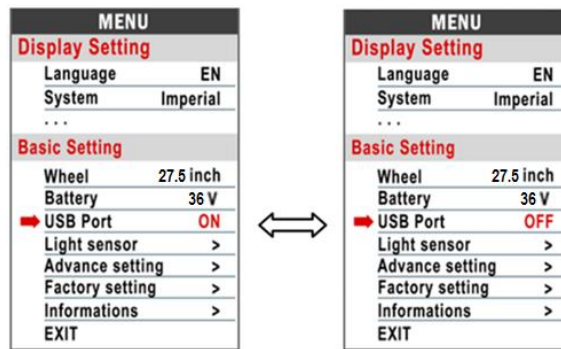

8.13 Light sensor: Light sensor item, press **MENU** Button , enter into Light sensor interface , Press **UP/DOWN** button select **OFF/ON**; select Sensitivity, press **UP/Down** Select sensitivity of light sensation **HI/MID/LO**.

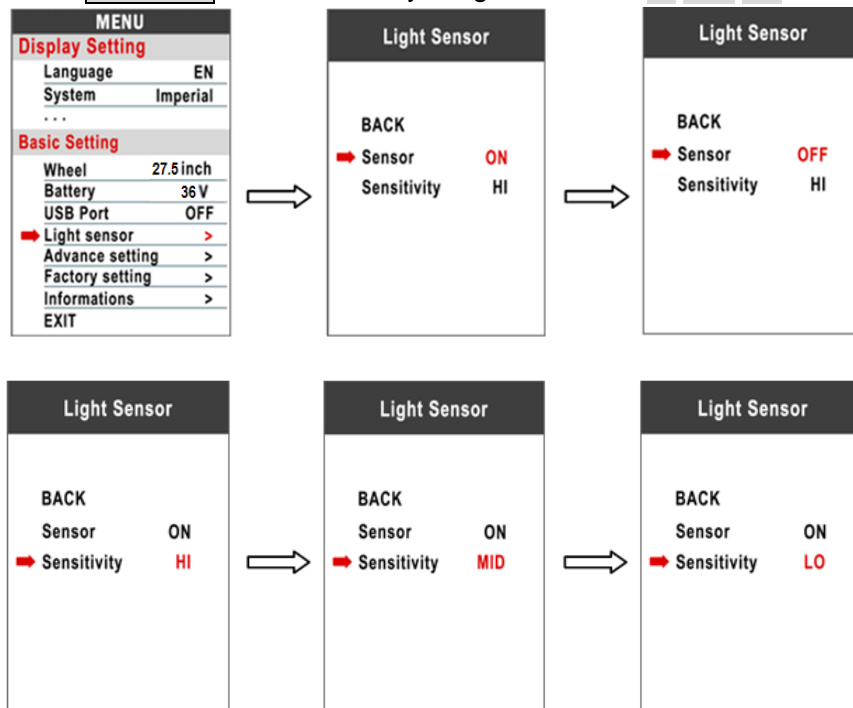

**8.14 Advance setting:** Press **MENU** button can get into the advance setting menu, default password is '1919'.

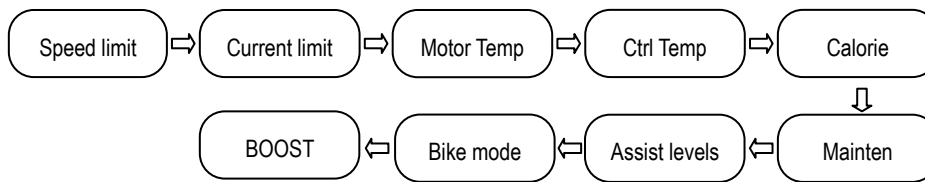
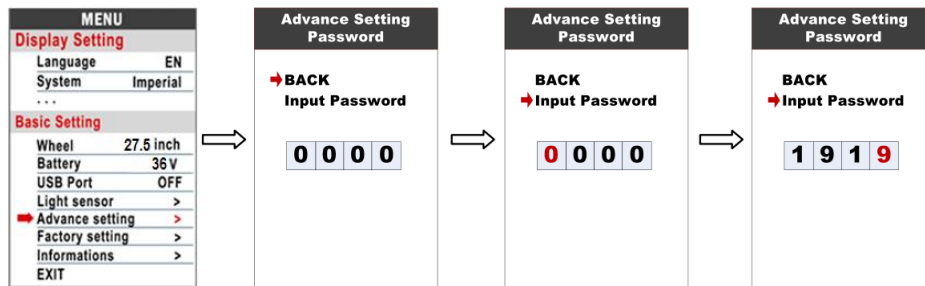

Advance Setting	
Speed limit	25 Km/h
Current limit	15 A
Motor Temp	28 °C
Ctrl Temp	28 °C
Calorie	0 Kcal
→ Mainten	0 Km
Assist levels	5
Bike mode	ECO
BOOST	N
BACK	
EXIT	

**8.15 Speed limit:** Display the speed limit value transmitted by the controller.

**8.16 Current limit:** Display the current limit value transmitted by the controller.

\*Speed limit and current limit are restricted by controller and motor.

**8.17 Motor Temp:** Display the motor temperature value.

**8.18 Ctrl Temp:** Display the controller temperature value.

**8.19 Calorie:** Display the calorie value.

**8.20 Mainten:** The meter can remind maintain information, according to mileage (ODO) . [Maintenance icon to be determined.](#)

**8.21 Assist levels:** This parameter can customize assist levels, options are 3/5/9.

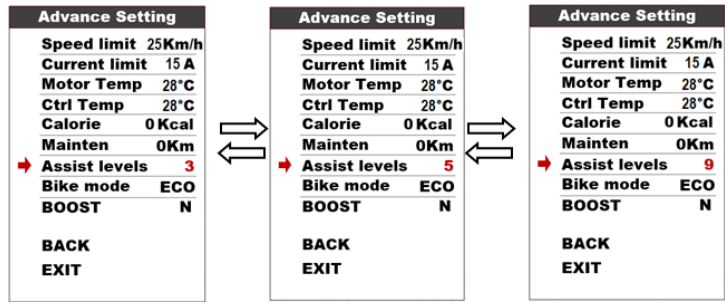

8.22 **Bike mode:** Press **UP/DOWN** button, select press **ECO/Sport** mode.

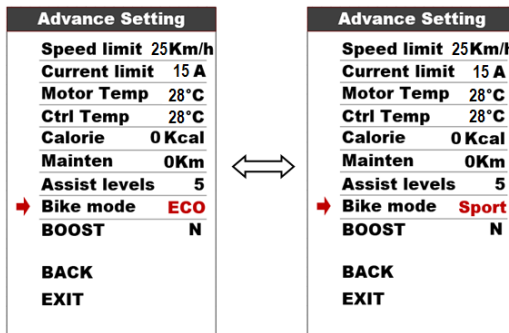

\* This feature needs to be supported by controller.

8.23 **BOOST:** Press **UP/DOWN** button, select press **N/Y** mode.

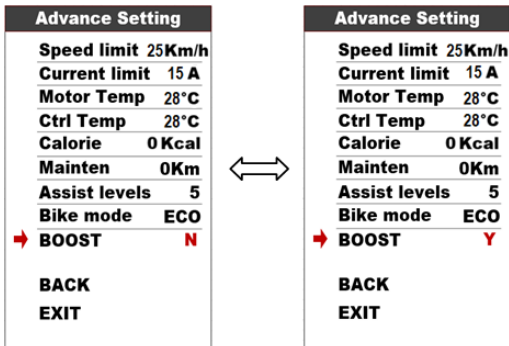

\* This feature needs to be supported by controller.

8.24 **Factory setting:** Press MENU button enter Restore Factory settings item, set YES will restore all parameter to factory settings.

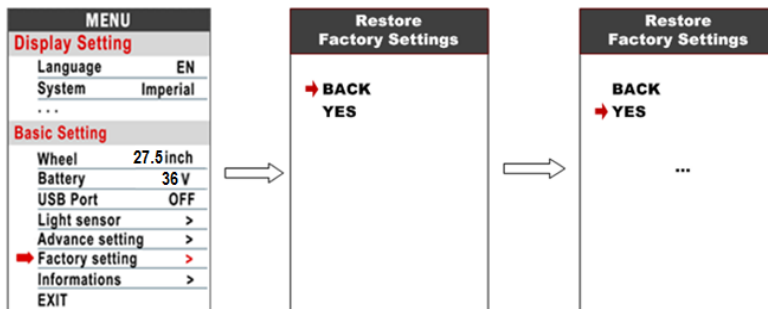

**8.25 Information:** Show information of the E-bike.

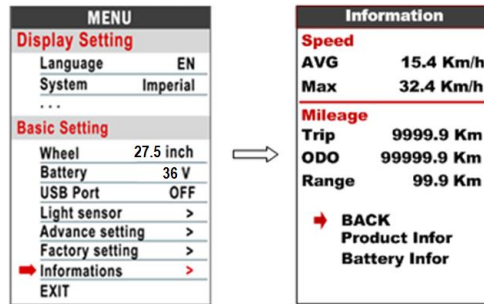

**8.26 Product info:** Get into this item can show hardware version software version...

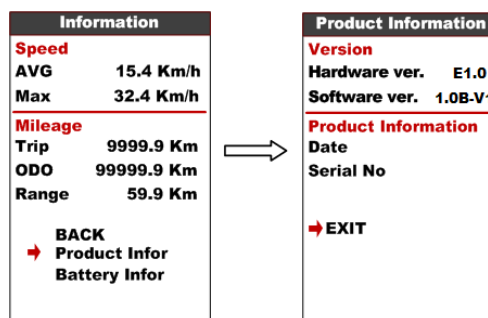

**8.27 Battery info :** Get into this item can show all information of battery, including Voltage, Current, Capacity, Health, Cycle times, Remaining Capacity , Full Charge Capacity , Temperature, Max Uncharge Times , Last Uncharge Times , CorVolt-1.

\*These information needs to be supported by battery communication.

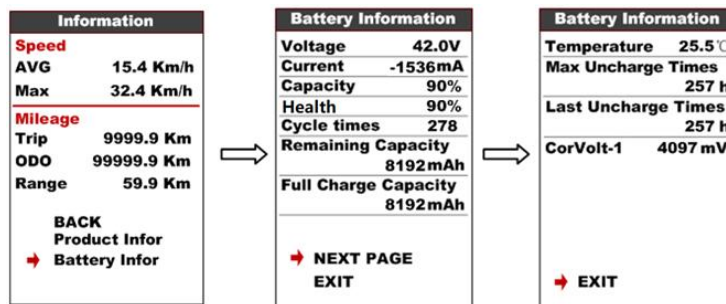

## 9. Error Code define

860C can show warning message,  icon shows on the screen, and show error code at the bottom of the screen, error code from 04~30, definition see the table below.

Error Code	Error description	Error display
04	Throttle on high position	Display <b>04H</b> on LOGO position
05	Throttle error	Display <b>05H</b> on LOGO position

07	High voltage protection	Display <b>07H</b> on LOGO position
08	Motor's hall sensor error	Display <b>08H</b> on LOGO position
09	Phase line of motor error	Display <b>09H</b> on LOGO position
10	Controller over temperature	Display <b>10H</b> on LOGO position
11	Motor over temperature	Display <b>11H</b> on LOGO position
12	Current sensor error	Display <b>12H</b> on LOGO position
13	Battery's temperature sensor error	Display <b>13H</b> on LOGO position
14	Motor's temperature sensor error	Display <b>14H</b> on LOGO position
15	controller's temperature sensor error	Display <b>15H</b> on LOGO position
21	Speed sensor error	Display <b>21H</b> on LOGO position
22	BMS communication error	Display <b>22H</b> on LOGO position
23	Head light error	Display <b>23H</b> on LOGO position
24	Head light sensor error	Display <b>24H</b> on LOGO position
25	Torque sensor error-Torque	Display <b>25H</b> on LOGO position
26	Torque sensor error-speed	Display <b>26H</b> on LOGO position
30	Communication error	Display <b>30H</b> on LOGO position



## 10. Assembly instructions

Please pay attention to the screw's torque value, damaged caused by excessive torque is not within the scope of the warranty.

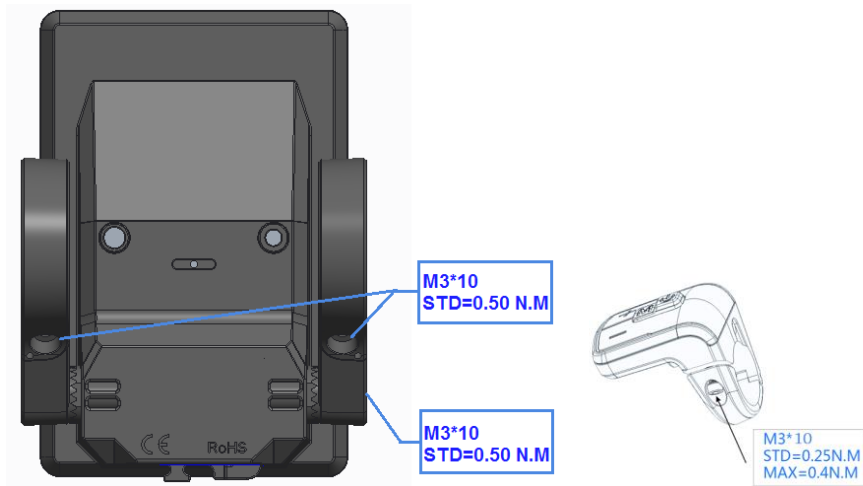

Clamps suit for 3 size of handlebar, 31.8mm, 25.4mm, 22.2mm, there are transfer rings for 25.4mm and 22.2mm, transfer ring must be assembled with the special directions.

## 11. Connector descriptions



## 12. Assist level instructions

Assist level can be customized, the highest level is 9, common used assist level see the table below:

3 level	5 level	9 level	
0	0	0	No power assist
		1	
	1	2	
1		3	
	2	4	
2		5	
	3	6	



---

		7	
	4	8	
3	5	9	

### **13. Certification**

CE / IP65 (water proof) / ROHS.